

Operating Instructions

METROTEC

Systems for Measuring and Controlling Oxygen

Z19

Oxygen meter

Z19 Series Measuring module

*** Version 1.5 ***

EC Declaration of Conformity

for

Oxygen measuring and control unit Type Z19 Series

This device has been designed for industrial purposes in accordance with:

*EN 61000-6-4**EN 61000-6-2*

It is compliant with the directives:

*EMC Directive: 2014/30/EU**Low Voltage Directive: 2014/35/EU**RoHs: 2011/65/EU**Radio Equipment Act Directive: 2014/53/EU*

This device complies with following standards:

*EN 61010-1**EN 61000-6-4**EN 61000-6-2**EN 63000**EN 300220-2*

Description of measures taken to assure compliance:

*Quality management system DIN EN ISO 9001:2015, No. 12 100 27736 TMS*This declaration becomes invalid if changes are made without
our consent.

Kirchheim/Teck, 09/04/2026

Place, Date









Signature

Table of Contents

1	Safety Instructions.....	4	8.2	Adjusting the Limit Value	10
2	Preface	5	8.3	Practical approach.....	11
3	Introduction	6	8.4	Definition of Analog Outputs	11
4	Measuring Principle	7	9	Interfaces	12
5	General Layout.....	8	9.1	Analog Interfaces.....	12
5.1	Measuring Module	8	9.2	Digital Interfaces.....	12
5.2	Sensor	8	10	METROTEC App for Windows	12
5.3	Description of the Module.....	8	11	METROTEC App for Android	12
6	Device Start-up	9	12	Terminal strip wiring diagram	13
6.1	Switching the Module on	9	13	Specifications.....	15
6.2	Measurement	9	14	Dimensions.....	16
6.3	Switching the Module off.....	9	14.1	Z19-F	16
7	Measured Value Output	9	14.2	Z19-H.....	16
8	Configuration.....	10			
8.1	Correcting the Measured Value...	10			

1 Safety Instructions

	<p>Please read these operating instructions carefully before installing and using the device. Improper use of the product will invalidate the warranty!</p>
	<p>The ambient conditions described in the Specifications chapter must be complied with in order to ensure the device's proper functioning and operational safety.</p>
	<p>The device may only be started up and operated by qualified and trained personnel. The operator of the device must ensure that all applicable regulations and guidelines are complied with. These are, among others, the EU Directive on work safety, national work safety legislation, accident prevention regulations, etc.</p>
	<p>Please ensure that the supply corresponds with the information given on the type plate. All coverings necessary to provide touch protection must be installed. In case the device is interconnected with other devices and/or installations, the consequences must be considered and appropriate precautions taken before switching the device on.</p>
	<p>In some cases, hot parts or surfaces may be unprotected during or after installing or uninstalling the device. Appropriate precautions must be taken to avoid injuries and/or damage.</p>
	<p>In case the device shows defects which suggest that it will not be possible to operate it safely, it must not be put into operation. We recommend to have the device inspected at least once a year at the factory or by a customer service representative.</p>
	<p>Disposal of the device must be performed according to the applicable regulations.</p>

2 Preface

The measuring device serves for recording oxygen partial pressures in gas atmospheres in connection with an oxygen sensor. Such sensors operate at high temperatures. Therefore, precautions must be taken to keep ignitable gas mixtures from reaching the sensor or the device. In case of the sensor ceramic breaking, sample gases may leak or air may enter the sample gas side. Should this occur, applicable measures must be provided for to save the environment and device parts from damage.

Wrong entries, leaks, corrosion, condensation, etc. may cause damage of the plant and erroneous measured values. It is vital to have all parts of the system maintained regularly.

The oxygen meters and the attachments have been produced and controlled subject to complete quality assurance in accordance with DIN EN-ISO 9001.

Installation and operation must be performed subject to compliance with all local and special regulations. These particularly include VDE and DVGW requirements.

Depending on the application, a periodic inspection of the measuring device in terms of measuring accuracy and function may be required and must be performed in the course of calibration and inspection procedures after initial commissioning.

3 Introduction

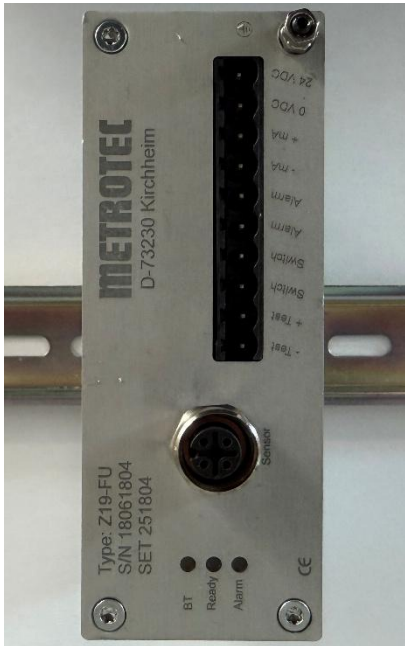

Z19-HU for DIN-rail mounting



Z19-FU for mounting-on-mounting plate

Types and application

Type	Kind of mounting	Connection
Z19-HU	DIN-rail	Analog signal 0/4-20 mA for e.g. PLC
Z19-FU	Mounting plate	Analog signal 0/4-20 mA for e.g. PLC
Z19-HZ	DIN-rail	METROTEC measuring unit type GSM
Z19-HU	Mounting plate	METROTEC measuring unit type GSM

4 Measuring Principle

Oxygen measuring devices are designed to process signals of an oxygen sensor made of stabilised zirconium dioxide. The zirconium dioxide, a ceramic also referred to as solid state electrolyte, is perfectly suited to serve as an oxygen-ion conductor at high temperatures.

Within certain temperature limits, which depend on the doping of the material concerned, such ion conductors are able to fill empty spaces in their crystal lattice with oxygen ions. The oxygen ions form itself on a conductive contact layer, which usually consists of platinum.

Thus, the oxygen concentration in a sample gas is essential for the extent of oxygen activity and accordingly the number of oxygen ions.

The basic structure of a sensor revolves around a solid state electrolyte which is contacted on both sides. One side of the electrolyte is operated by a reference gas, such as air, the other one with sample gas. The mechanical design of the sensor separates both gas sides from each other, thus preventing the gases to mix.

Depending on the application, either heated or unheated sensors will be used. Unheated sensors are predominantly used in ovens, while heated sensors come into play in applications, where gases below 600 degrees Celsius are to be measured. (The measuring principle requires a minimum temperature of 500 – 650 degrees Celsius.)

Heated sensors are adjusted to a specific target temperature by means of a temperature controller integrated in the processing electronics. The temperature of heated and unheated sensors is measured by the electronic unit and is an essential element in the calculation of the oxygen oxygen level (oxygen partial pressure).

The value is calculated by means of the following formula:

$$EMK = \frac{R \cdot T}{4 \cdot F} \cdot \ln\left(\frac{P_1}{P_2}\right)$$

whereby

- R = 8.31J/mol K
- T = Temperature in Kelvin
- F = 96493 As/mol
- P1 = Oxygen partial pressure on the reference side with 0.20946 bar
- P2 = Oxygen partial pressure on the sample gas side
- EMF = Electromotive force in Volt

5 General Layout

5.1 Measuring Module

The Z19-HU and Z19-FU series measurement modules offer the following functions:

- Measurement of oxygen partial pressure in connection with a separate series A sensor
- Output of measured value 4 to 20 mA, (0 to 20 mA optional)
- Generation of alarms

The Z19-HZ and Z19-FZ series measurement modules offer the following functions:

- Measurement of the sensor EMF connection with a separate series A sensor
- Output of the measured value in millivolts and the thermocouple voltage of a type “S” thermocouple

The module is parametrised after the installation, if necessary, and will operate permanently with these settings.

Note:

In order to implement extensive changes and to display measured values, the "METROTEC App" for Android" or "METROTEC App for Windows" is required.

5.2 Sensor

The measuring module requires a separate extractive oxygen sensor to enable its functioning. Connecting the sensor: See separate operating instructions of sensor.

5.3 Description of the Module

The front side is divided in several areas. These are LED display, sensor plug and cable connector.

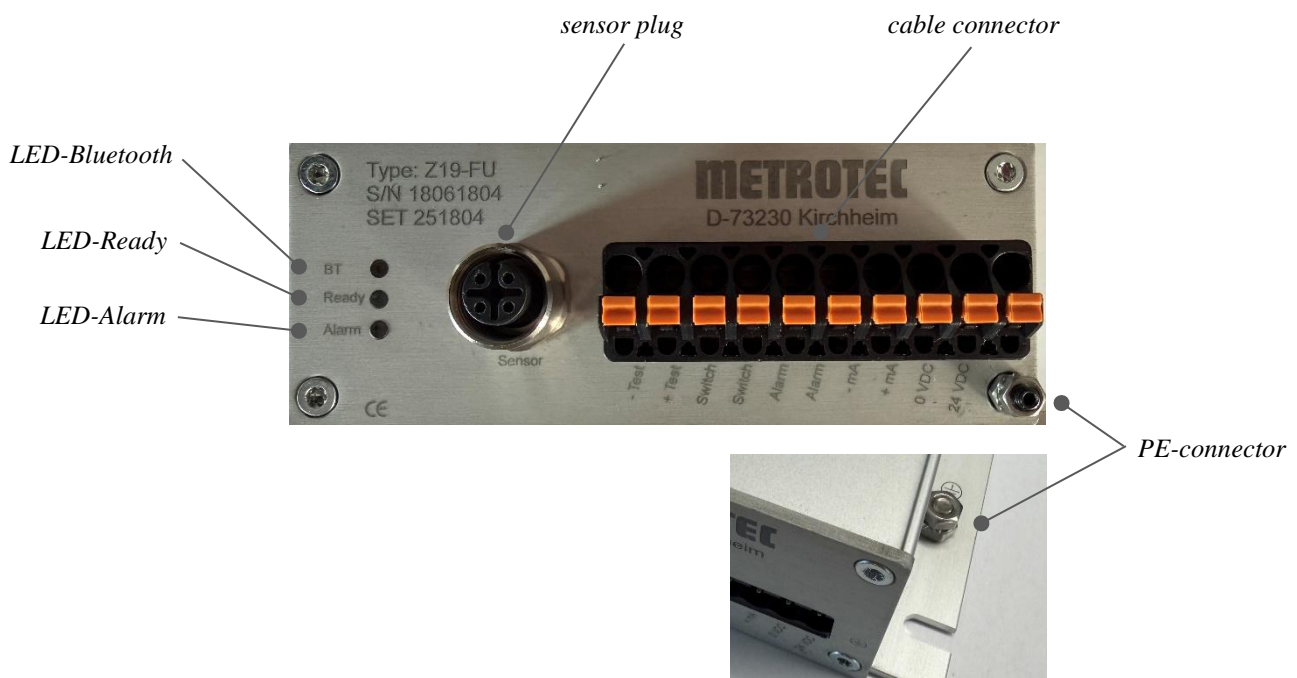

6 Device Start-up

6.1 Switching the Module on

The measuring module is wired up in accordance with the wiring diagram. The module is ready to start when the supply voltage is applied.

After heating up the sensor, the green "Ready" LED signals readiness, which otherwise shows a red light. If the currently measured value is below the set limit, the alarm LED lights green, otherwise the colour red signals a collective alarm.

After heating up, the measuring module delivers the transmitted measured value at the mA output.

6.2 Measurement

After the starting routine the device is ready for use and can determine the oxygen content in gases. This requires supplying the sample gas according to the sensor type. Alternatively the sample gas contains the sensor. See the operating instructions of the respective sensor.

6.3 Switching the Module off

It is advisable to keep the device continuously in operation. This will avoid the condensation of steam in heated sensors which may cause corrosion.

Should the unit need to be switched off, the energy supply of the measuring module will be interrupted. See the operating instructions of the respective sensor.

7 Measured Value Output

The measuring module can output the measured value in linear mode. The standard setting is 0-21 % O₂ "linear" at 4-20 mA. Another measuring range from 0-1000 ppm O₂ can be activated by means of a wire jumper.

Note 1:

This assignment is permanent and can only be changed on location by means of "METROTEC App"

Note 2:

The measuring ranges can be set to different values than the above ones to match customer specifications.

8 Configuration

Configuration changes can be made directly on the device. An active Bluetooth connection is required.

After the measuring module is switched on, the Bluetooth interface is active for 3 minutes, which is indicated by the green flashing LED BT. Within this time, a connection to the measuring module must be established. A successful connection is indicated by the continuous green glow of the BT LED. The connection is maintained until the measuring module is actively disconnected.

After the 3 minutes without connection, the Bluetooth interface turns off. A reactivation is possible by switching the power supply on and off.

Note:

The METROTEC app for Android or the METROTEC App for Windows is required to make extensive changes and view readings. For more information, see the operating instructions for each app.

The METROTEC App is for free download at <https://metrotec.eu>

8.1 Correcting the Measured Value

The current measured value can be corrected, if required. In this case it is advisable to make the adjustment after a stable measurement has been achieved and possible errors in measurement can be ruled out.

An adjustment can only be done by means of the "METROTEC App".

8.2 Adjusting the Limit Value

The limit value is switched when the current measured value is below the current limit value. The limit value is within the programmed measuring range (measuring range 1 only). An alarm status is signalled by the alarm LED.

At the same time the semiconductor relay, which is connected to the terminals Alarm and Alarm of the terminal strip, switches.



Any change can only be done by means of the "METROTEC App".

8.3 Practical approach

In many cases the visual display of the mA signal is not within sight distance of the measuring module. Thus our recommendation is to disconnect the mA connection from terminals "- mA" and "+ mA" and replace it by a commercially available portable mA measuring device.

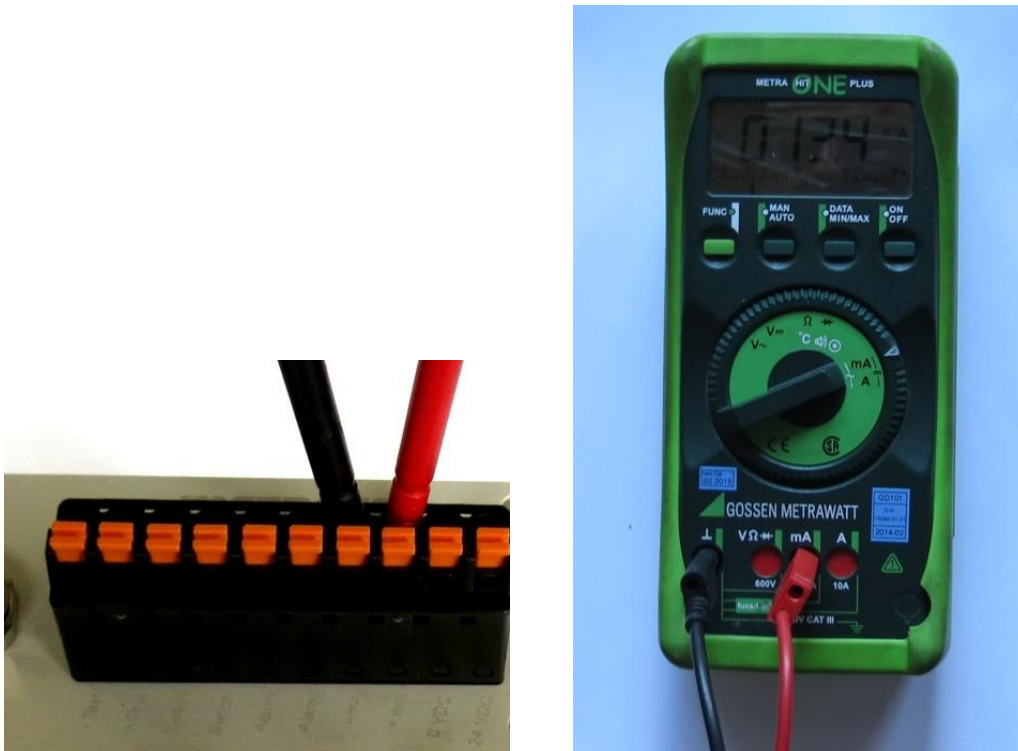

If need be, the "METROTEC App" can be used to check and adjust settings. After finishing these settings the previously disconnected connections are restored.

8.4 Definition of Analog Outputs

Switching the measuring ranges to the analog output occurs by means of a jumper between the terminals "Switch" and "Switch".

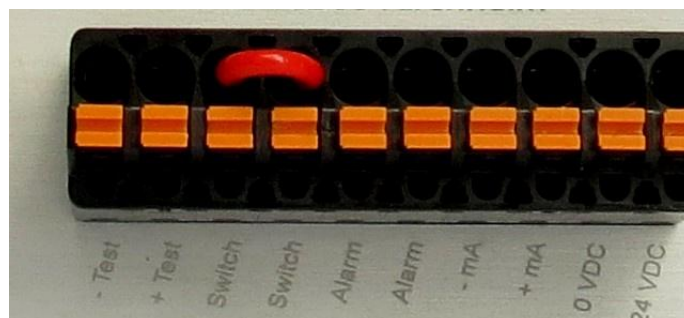

9 Interfaces

9.1 Analog Interfaces

There is one 4-20 mA interface.

9.2 Digital Interfaces

Semiconductor relay for collective alarm

10 METROTEC App for Windows

The "*METROTEC App for Windows*" enables you to look at measuring values and change configuration settings.

An exact description is available in the "*METROTEC App for Windows*" operating instructions.

11 METROTEC App for Android

The "*METROTEC App for Android*" enables you to look at measuring values and change configuration settings.

An exact description is available in the "*METROTEC App for Android*" operating instructions.

12 Terminal strip wiring diagram

Z19-HU, Z19-FU



Terminal	Type description	Definition
PE ¹	Protective Earth	PE connection
24V DC	+ 24V DC (VDC)	Power
0 VDC	- (GND)	Power
+ mA ²	mA+	Measured value output +
- mA	mA-	Measured value output -
Alarm ³	Alarm relay	Collective alarm
Alarm	Alarm relay	Collective alarm
Switch	Bridge to Switch terminal	Switching from Measuring range 1 to Measuring range 2
Switch	Bridge to Switch terminal	
+ Test		Test for Service
- Test		Test for Service

Note:

¹To ensure proper operation, the protective earth must be connected

²mA output is electrically isolated

³Digital outputs are floating semiconductor contacts (1A, 24V)

Z19-HZ, Z19-FZ

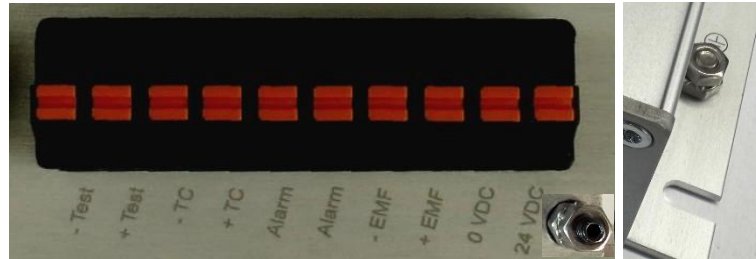

Terminal	Type description	Definition
PE ¹	Protective Earth	PE connection
24 VDC	+ 24 VG (VDC)	Power
0 VDC	- (GND)	Power
+ EMF ²	mV +	EMF +
- EMF	mV-	EMF -
Alarm ³	Alarm relay	Collective alarm
Alarm	Alarm relay	Collective alarm
+ TC	Temperature output	Thermocouple + Type S
- TC	Temperature output	Thermocouple - Type S
+ Test		Test for Service
- Test		Test for Service

Note:

¹To ensure proper operation, the protective earth must be connected

²EMF output is electrically isolated

³Digital outputs are floating semiconductor contacts (1A, 24V)

13 Specifications

Measuring range Z19HU, Z19-FU	Section 1 0-21 % O ₂ Section 2 0-1000 ppm
Measuring range Z19HZ, Z19-FZ	EMF 0 – 1500 mV
Ambient temperature	0 to 45 degrees Celsius
Measuring precision*	+/- 1,5 %
Measuring accuracy	+ 0,5 mV of the sensor EMF minimum - 0,5 ppm - 2 mV of the sensor EMF minimum + 1,5 ppm +/- 2 degrees Celsius +/- 2% of the mA output +/- 2% of the log oxygen partial pressure
Dimensions	ca. 40 x 130 x 120 mm (HxWxD)
Weight	0.5 kg
Supply voltage	24 VG (22.6 to 26.4 Volt) Observe Type Plate! Wrong power supply can destroy the module!
Power	Acc. to sensor type, ca. 20 VA max.
Analog output	4 – 20 mA potential-free (0-20mA optional)
Relay output	for collective alarm, 1A, 24 V (ohmic)

**Measurement precision is calculated out of measuring values connected with oxygen sensor type A19 corresponding DIN 55350*

14 Dimensions

14.1 Z19-F

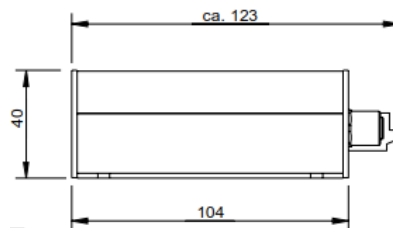
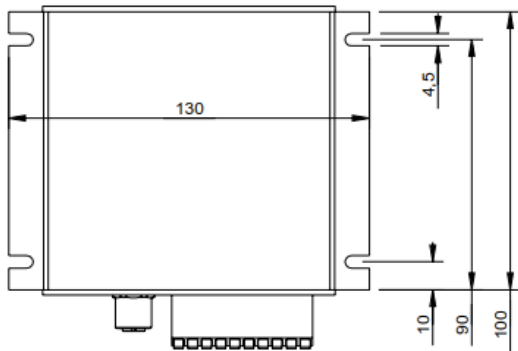
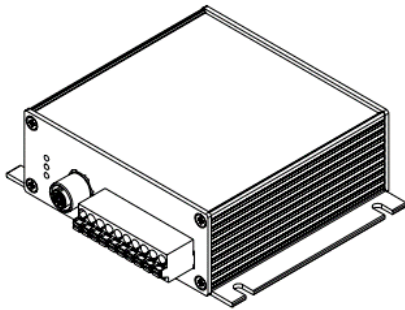

14.2 Z19-H

